

BOBCAT COMPANY PRICE PAGES NA VersaHANDLER® TTC – ATTACHMENTS



Please note the following when using Bobcat Price Pages:

- All prices are shown in U.S. dollars.
- Check BobcatNET Pricing Homepage for current Canadian exchange rate.
- All Parts Pricing valid only for North America.
- Prices and specifications are subject to change without notice.

THE FOLLOWING UPDATES HAVE BEEN MADE TO THIS DOCUMENT:

Date	Description of Change
01/01/15	Effective Thursday, January 1 st , 2015 Bobcat Company has adjusted the SLP of select options and power units.
02/26/2015	Removed part numbers: 6810279, 6810283, 6810285, 6810287, 6810289, 6810291, 6812146, 6812150, 6812152, 6810221, 6810293, 6812148, 6810281, 6810299, 6810295
07/01/15	Effective Wednesday, July 1 st , 2015 Bobcat Company has adjusted the SLP of select attachment options.
11/5/15	Added HS8 spreader
2/24/16	Removed PN 6810297 and 7140720. These products have been discontinued.
7/1/16	Effective Friday, July 1 st 2016, Bobcat Company has adjusted the SLP of select attachment options.
8/2/16	Added V519 to attachments
8/15/16	Added V519 to floating pallet forks.
8/28/16	Revised Spec disclaimer for consistency
4/20/17	Added Combo Buckets Max Clamping Force Spec
6/30/17	Added new 723 attachments & removed carriers that cannot be ordered
7/10/17	Effective Monday, July 10 th 2017, Bobcat Company has adjusted the SLP of select attachment options.
01/01/18	Effective Thursday, January 1 st , 2018 Bobcat Company has adjusted the SLP of select options and power units.

**Certain specification(s) are based on engineering calculations and are not actual measurements. Specification(s) are provided for comparison purposes only and are subject to change without notice. Specification(s) for your individual Bobcat equipment will vary based on normal variations in design, manufacturing, operating conditions, and other factors.*

Prices and Specifications
Prices

VersaHANDLER TTC Attachments

North American Suggested List

Subject to Change Without Notice

All Prices in U.S. Dollars

2017 Price Book

Check BobcatNET Pricing Homepage for current Canadian exchange rate.

Page 1 of 25

Bobcat® and the Bobcat logo are trademarks of Bobcat Company.

**Only these Attachments meet the ASME B56.6 Requirements for Telescopic Tool Carriers.
Other attachments are not approved for use with the VersaHANDLER TTC.**

BOBCAT COMPANY PRICE PAGES NA VersaHANDLER® TTC – ATTACHMENTS



Please note the following when using Bobcat Price Pages:

- All prices are shown in U.S. dollars.
- Check BobcatNET Pricing Homepage for current Canadian exchange rate.
- All Parts Pricing valid only for North America.
- Prices and specifications are subject to change without notice.

Prices and Specifications
Prices

VersaHANDLER TTC Attachments

North American Suggested List

Subject to Change Without Notice

All Prices in U.S. Dollars

2017 Price Book

Check BobcatNET Pricing Homepage for current Canadian exchange rate.

Page 2 of 25

Bobcat® and the Bobcat logo are trademarks of Bobcat Company.

Only these Attachments meet the ASME B56.6 Requirements for Telescopic Tool Carriers.

Other attachments are not approved for use with the VersaHANDLER TTC.

ADAPTER FRAME

VersaHANDLER® TTC ATTACHMENT

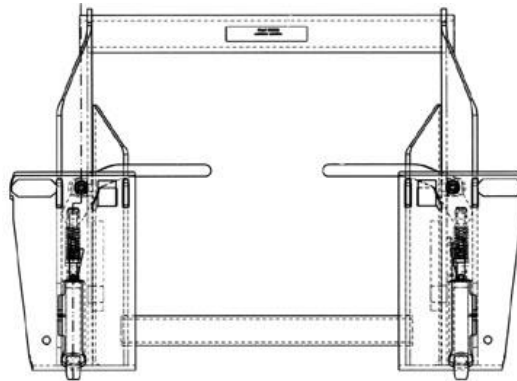

QUICK SPECS

Operating Weight225 lbs.

PART NUMBER	DESCRIPTION	ATTACHMENT	SLP IN US \$
-------------	-------------	------------	--------------

(V518,V723)

6812846	VH ADAPTER FRAME.....	\$1,269.00
----------------	-----------------------	-------------------

DESTINATION CHARGE

Refer to BobQuote or BobcatNET>>Other Resources>>Pricing Homepage for current Destination and Fuel Charges.

ATTACHMENT	ASSEMBLY REQUIRED	INSTALLATION TIME (HRS.)
------------	-------------------	--------------------------

Adapter Frame.....	None.....	-
--------------------	-----------	---

Prices and Specifications
Prices

VersaHANDLER TTC Attachments

North American Suggested List

Subject to Change Without Notice

All Prices in U.S. Dollars

2017 Price Book

Check BobcatNET Pricing Homepage for current Canadian exchange rate.

Page 3 of 25

Bobcat® and the Bobcat logo are trademarks of Bobcat Company.

Only these Attachments meet the ASME B56.6 Requirements for Telescopic Tool Carriers.

Other attachments are not approved for use with the VersaHANDLER TTC.

ANGLE BROOM

VersaHANDLER® TTC ATTACHMENT

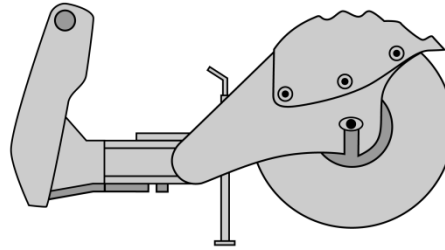

QUICK SPECS

Operating Weight	<u>84"</u> 944 lbs.
Sweep Width Straight	84"
Sweep Width Fully Angled	77" @ 25°
Broom Angling	Hydraulic Cylinder
Oscillation	Fixed
Drive System	Hydraulic Motor Direct Drive
Flow Range	15-28 GPM
Broom Bristle Diameter	32"
Bristle Material	Replaceable Polypropylene
Number of Bristle Sections	44 Zig-Zag, 2 Straight

PART NUMBER	ATTACHMENT DESCRIPTION	SLP IN US \$
----------------	---------------------------	--------------

(V519) 6905806	84" ANGLE BROOM (VersaHandler must be equipped with Attachment Control Kit to operate Angle Broom)	\$6,024.00
---------------------------------	--------------------------------------------------------------------------------------------------------------------	-------------------

DESTINATION CHARGE

Refer to BobQuote or BobcatNET>>Other Resources>>Pricing Homepage for current Destination and Fuel Charges.

ATTACHMENT	ASSEMBLY REQUIRED	INSTALLATION TIME (HRS.)
------------	-------------------	-----------------------------

Angle Broom	None.....	-
-------------------	-----------	---

Prices and Specifications
Prices

VersaHANDLER TTC Attachments

North American Suggested List

Subject to Change Without Notice

All Prices in U.S. Dollars

2017 Price Book

Check BobcatNET Pricing Homepage for current Canadian exchange rate.

Page 4 of 25

Bobcat® and the Bobcat logo are trademarks of Bobcat Company.

Only these Attachments meet the ASME B56.6 Requirements for Telescopic Tool Carriers.
Other attachments are not approved for use with the VersaHANDLER TTC.

AUGER

VersaHANDLER® TTC ATTACHMENT



Auger Drive Unit

QUICK SPECS

	<u>Model</u> <u>15C</u>	<u>Model</u> <u>15H</u>	<u>Model</u> <u>30C</u>	<u>Model</u> <u>30H</u>	<u>Model</u> <u>35PH</u>
Ship Weight (Auger Drive)	245 lbs.	241 lbs.	263 lbs.	257 lbs.	325 lbs.
Ship Weight (Mtg. Frame).....	189 lbs.	189 lbs.	189 lbs.	189 lbs.	189 lbs.
Operating Weight (less bit).....	374 lbs.	370 lbs.	392 lbs.	386 lbs.	454 lbs.
Digging Depth					
(without extensions).....	62"	62"	62"	62"	72"
Shaft Diameter - Round.....	2.5"	-	2.5"	-	-
Shaft Diameter - Hex.....	2.0"	2.0"	2.0"	2.0"	2.5"
RPM					
@ 12 gpm (45 L/min.).....	57 rpm	57 rpm			
@ 17 gpm (64 L/min.).....	80 rpm	80 rpm	41 rpm	41 rpm	
@ 18 gpm (68 L/min.).....					46 rpm
@ 21 gpm (70 L/min.).....	99 rpm	99 rpm	51 rpm	51 rpm	
@ 22 gpm (83 L/min.).....					56 rpm
@ 23 gpm (87 L/min.).....	109 rpm	109 rpm	56 rpm	56 rpm	
@ 26 gpm (98 L/min.).....					64 rpm
@ 30 gpm (114 L/min.).....			70 rpm	70 rpm	77 rpm
@ 32 gpm (121 L/min.).....					82 rpm
@ 34 gpm (129 L/min.).....					87 rpm
@ 36 gpm (136 L/min.).....					92 rpm
@ 37 gpm (140 L/min.).....			90 rpm	90 rpm	
@ 38 gpm (144 L/min.).....					98 rpm
Torque					
@ 2000 psi (19,788 kPa).....	1300 ft.lb. (1763 Nm)	1300 ft.lb. (1763 Nm)	2520 ft.lb. (3417 Nm)	2520 ft.lb. (3417 Nm)	2387 ft.lb. (3237 Nm)
@ 2400 psi (16,547 kPa).....	1560 ft.lb. (2115 Nm)	1560 ft.lb. (2115 Nm)	3024 ft.lb. (4100 Nm)	3024 ft.lb. (4100 Nm)	2864 ft.lb. (3884 Nm)
@ 2600 psi (17,926 kPa).....					3103 ft.lb. (4208 Nm)
@ 2700 psi (18,616 kPa).....	1775 ft.lb. (2379 Nm)	1775 ft.lb. (2379 Nm)	3402 ft.lb. (4213 Nm)	3402 ft.lb. (4213 Nm)	
@ 3000 psi (20,684 kPa).....	1950 ft.lb. (2644 Nm)	1950 ft.lb. (2644 Nm)	3780 ft.lb. (5125 Nm)	3780 ft.lb. (5125 Nm)	
@ 3200 psi (22,753 kPa).....					3819 ft.lb. (5179 Nm)
@ 3300 psi (22,753 kPa).....	2415 ft.lb. (2908 Nm)	2415 ft.lb. (2908 Nm)	4158 ft.lb. (5638 Nm)	4158 ft.lb. (5638 Nm)	

Prices and Specifications
Prices

VersaHANDLER TTC Attachments

North American Suggested List

Subject to Change Without Notice

All Prices in U.S. Dollars

2017 Price Book

Check BobcatNET Pricing Homepage for current Canadian exchange rate.

Page 5 of 25

Bobcat® and the Bobcat logo are trademarks of Bobcat Company.

Only these Attachments meet the ASME B56.6 Requirements for Telescopic Tool Carriers.

Other attachments are not approved for use with the VersaHANDLER TTC.

AUGER

VersaHANDLER® TTC ATTACHMENT

@ 3500 psi (24,132 kPa).....2275 ft.lb. 2275 ft.lb. 4410 ft.lb. 4410 ft.lb. 4177 ft.lb.
(3084 Nm) (3084 Nm) (5979 Nm) (5979 Nm) (5664 Nm)

PART NUMBER	ATTACHMENT DESCRIPTION	SLP IN US \$
(V519)		
6809442	MODEL 15C AUGER DRIVE UNIT (Must also order Mounting Frame and Bit)	\$1,696.00
7145345	MODEL 15H HEX SHAFT AUGER DRIVE UNIT (Must also order Mounting Frame and Bit)	\$1,696.00
6809445	MODEL 30C AUGER DRIVE UNIT (Must also order Mounting Frame and Bit)	\$2,217.00
7138264	MODEL 30H HEX SHAFT AUGER DRIVE UNIT (Must also order Mounting Frame and Bit)	\$2,217.00
7220280	MODEL 35PH AUGER DRIVE UNIT (Must also order Mounting Frame and Bit)	\$3,590.00

PART NUMBER	DEALER INSTALLED ACCESSORIES – ORDER FROM SALES DESCRIPTION	SLP IN US \$
-------------	-------------------------------------------------------------	--------------

MUST ORDER MOUNTING FRAME OR ADAPTER FRAME

(V519)		
6812980	AUGER 15C/H, 30C/H MOUNTING FRAME (Includes Mounting Hardware)	\$406.00
(V519)		
7223507	MOUNTING FRAME (Includes Mounting Hardware)	\$484.00

Prices and Specifications
Prices

VersaHANDLER TTC Attachments

North American Suggested List

Subject to Change Without Notice

All Prices in U.S. Dollars

2017 Price Book

Check BobcatNET Pricing Homepage for current Canadian exchange rate.

Page 6 of 25

Bobcat® and the Bobcat logo are trademarks of Bobcat Company.

**Only these Attachments meet the ASME B56.6 Requirements for Telescopic Tool Carriers.
Other attachments are not approved for use with the VersaHANDLER TTC.**

AUGER

VersaHANDLER® TTC ATTACHMENT

PART NUMBER	DEALER INSTALLED ACCESSORIES – ORDER FROM PARTS DESCRIPTION
-------------	-------------------------------------------------------------

For current Dealer Installed Accessories pricing, reference BobQuote or Dealer Parts Department.

STANDARD AUGER BITS & ACCESSORIES

Charcoal Color, Round Drive, 49" Length, Double Flight, Variable Tooth Angle: 40° or 50°

6666891	6" BIT PARTS	\$ _____
	(Ship Weight 60 lbs.)	
6666892	9" BIT PARTS	\$ _____
	(Ship Weight 91 lbs.)	
6666893	12" BIT PARTS	\$ _____
	(Ship Weight 128 lbs.)	
6666894	15" BIT PARTS	\$ _____
	(Ship Weight 119 lbs.)	
6666895	18" BIT PARTS	\$ _____
	(Ship Weight 160 lbs.)	
6666896	24" BIT PARTS	\$ _____
	(Ship Weight 203 lbs.)	
6666897	30" BIT PARTS	\$ _____
	(Ship Weight 275 lbs.)	
6666898	36" BIT (MODEL 15 & 30)..... PARTS	\$ _____
	(Ship Weight 380 lbs.)	
6666899	18" TREE PLANTING BIT PARTS	\$ _____
	(Ship Weight 140 lbs.)	
6666900	24" TREE PLANTING BIT PARTS	\$ _____
	(Ship Weight 162 lbs.)	
6666901	30" TREE PLANTING BIT PARTS	\$ _____
	(Ship Weight 236 lbs.)	
6666902	36" TREE PLANTING BIT PARTS	\$ _____
	(Ship Weight 305 lbs.)	

HEAVY DUTY AUGER BITS

Orange Color, Hex Drive, 42" Length, Single Flight

6674957	6" BIT PARTS	\$ _____
	(If installed on a 15C or 30C Auger drive unit, a 5/8" Pin Kit P/N 6809733 is required)	
	(Ship Weight 46 lbs.)	
6674958	9" BIT PARTS	\$ _____
	(If installed on a 15C or 30C Auger drive unit, a 5/8" Pin Kit P/N 6809733 is required)	
	(Ship Weight 59 lbs.)	
6674959	12" BIT PARTS	\$ _____
	(If installed on a 15C or 30C Auger drive unit, a 5/8" Pin Kit P/N 6809733 is required)	
	(Ship Weight 76 lbs.)	
6674960	16" BIT PARTS	\$ _____
	(If installed on a 15C or 30C Auger drive unit, a 5/8" Pin Kit P/N 6809733 is required)	
	(Ship Weight 97 lbs.)	
6675034	18" BIT PARTS	\$ _____
	(If installed on a 15C or 30C Auger drive unit, a 5/8" Pin Kit P/N 6809733 is required)	
6674961	20" BIT PARTS	\$ _____
	(If installed on a 15C or 30C Auger drive unit, a 5/8" Pin Kit P/N 6809733 is required)	
	(Ship Weight 117 lbs.)	
6674962	24" BIT PARTS	\$ _____
	(If installed on a 15C or 30C Auger drive unit, a 5/8" Pin Kit P/N 6809733 is required)	
	(Ship Weight 151 lbs.)	
6674963	30" BIT PARTS	\$ _____
	(If installed on a 15C or 30C Auger drive unit, a 5/8" Pin Kit P/N 6809733 is required)	
	(Ship Weight 193 lbs.)	

Prices and Specifications
Prices

VersaHANDLER TTC Attachments

North American Suggested List

Subject to Change Without Notice

All Prices in U.S. Dollars

2017 Price Book

Check BobcatNET Pricing Homepage for current Canadian exchange rate.

Page 7 of 25

Bobcat® and the Bobcat logo are trademarks of Bobcat Company.

Only these Attachments meet the ASME B56.6 Requirements for Telescopic Tool Carriers.

Other attachments are not approved for use with the VersaHANDLER TTC.

AUGER

VersaHANDLER® TTC ATTACHMENT

PART NUMBER	DEALER INSTALLED ACCESSORIES – ORDER FROM PARTS DESCRIPTION
-------------	-------------------------------------------------------------

For current Dealer Installed Accessories pricing, reference BobQuote or Dealer Parts Department.

6674964	36" BIT PARTS \$ _____ (If installed on a 15C or 30C Auger drive unit, a 5/8" Pin Kit P/N 6809733 is required) (Ship Weight 270 lbs.)	
6674965	42" BIT PARTS \$ _____ (If installed on a 15C or 30C Auger drive unit, a 5/8" Pin Kit P/N 6809733 is required) (Ship Weight 302 lbs.)	

ROCK AUGER BITS

White Color, Hex Drive, 42" Length, Single Flight

7169665	6" BIT PARTS \$ _____ (Ship Weight 64 lbs.)	
7169666	9" BIT PARTS \$ _____ (SHIP WEIGHT 78 LBS.)	
7169667	12" BIT PARTS \$ _____ (Ship Weight 102 lbs.)	
7169668	16" BIT PARTS \$ _____ (Ship Weight 123 lbs.)	
7169669	18" BIT PARTS \$ _____ (Ship Weight 149 lbs.)	
7169670	20" BIT PARTS \$ _____ (Ship Weight 152 lbs.)	
7169671	24" BIT PARTS \$ _____ (Ship Weight 195 lbs.)	
7169672	30" BIT PARTS \$ _____ (Ship Weight 225 lbs.)	

HEAVY DUTY AUGER BITS – 35PH AUGER DRIVE

7243233	8" BIT PARTS \$ _____ (Ship Weight 115 lbs.)	
7243234	12" BIT PARTS \$ _____ (Ship Weight 130 lbs.)	
7243235	18" BIT PARTS \$ _____ (Ship Weight 165 lbs.)	
7243236	24" BIT PARTS \$ _____ (Ship Weight 225 lbs.)	
7243237	30" BIT PARTS \$ _____ (Ship Weight 295 lbs.)	
7243238	36" BIT PARTS \$ _____ (Ship Weight 350 lbs.)	
7243239	48" BIT PARTS \$ _____ (Ship Weight 495 lbs.)	

Prices and Specifications
Prices

VersaHANDLER TTC Attachments

North American Suggested List

Subject to Change Without Notice

All Prices in U.S. Dollars

2017 Price Book

Check BobcatNET Pricing Homepage for current Canadian exchange rate.

Page 8 of 25

Bobcat® and the Bobcat logo are trademarks of Bobcat Company.

Only these Attachments meet the ASME B56.6 Requirements for Telescopic Tool Carriers.

Other attachments are not approved for use with the VersaHANDLER TTC.

AUGER

VersaHANDLER® TTC ATTACHMENT

PART NUMBER	DEALER INSTALLED ACCESSORIES – ORDER FROM PARTS DESCRIPTION
-------------	-------------------------------------------------------------

For current Dealer Installed Accessories pricing, reference BobQuote or Dealer Parts Department.

ROCK AUGER BITS – 35PH AUGER DRIVE

7243240	8" BIT PARTS	\$ _____
	(Ship Weight 118 lbs.)	
7243241	12" BIT PARTS	\$ _____
	(Ship Weight 130 lbs.)	
7243242	18" BIT PARTS	\$ _____
	(Ship Weight 165 lbs.)	
7243243	24" BIT PARTS	\$ _____
	(Ship Weight 210 lbs.)	
7243244	30" BIT PARTS	\$ _____
	(Ship Weight 300 lbs.)	

PART NUMBER	DEALER INSTALLED ACCESSORIES – ORDER FROM PARTS DESCRIPTION
-------------	-------------------------------------------------------------

Heavy Duty Auger Bits Accessories/Rock Auger Bits Accessories

6809733	5/8" (.625) PIN KIT PARTS	\$ _____
	(Used for retention of hex bits on 15C and 30C Auger drive units) (Ship Weight 11 lbs.)	
6679807	48" ADJUSTABLE HEX EXTENSION PARTS	\$ _____
	(For Model 15H, 15C, 30H and 30C Augers) (Ship Weight 48 lbs.)	
6662876	24" ADJUSTABLE HEX EXTENSION PARTS	\$ _____
	(For Model 15H, 15C, 30H and 30C Augers) (Ship Weight 33 lbs.)	
6662874	ROUND SHAFT TO HEX BIT ADAPTER, CAST PARTS	\$ _____
	(For Model 15 & 30 Augers with Round Output Shaft) (Ship Weight 19 lbs.)	
6662875	HEX SHAFT TO ROUND BIT ADAPTER, CAST PARTS	\$ _____
	(For Model 15H, 15C, 30H and 30C Augers with Hex Output Shaft) (Ship Weight 20 lbs.)	
7137091	HEX SHAFT TO ROUND BIT ADAPTER, SLEEVE PARTS	\$ _____
	(For Model 15H, 15C, 30H and 30C Augers with Hex Output Shaft) (5/8" Pin Kit P/N 6809733 is required.) (Sleeve slides over hex shaft, converting it to round) (Ship Weight 3 lbs.)	
7243729	48" ADJUSTABLE HEX EXTENSION PARTS	\$ _____
	(For 35PH Auger Drives) (Shipping Weight 105lbs.)	

DESTINATION CHARGE
Refer to BobQuote or BobcatNET>>Other Resources>>Pricing Homepage for current Destination and Fuel Charges.

ATTACHMENT	ASSEMBLY REQUIRED	INSTALLATION TIME (HRS.)
------------	-------------------	--------------------------

Auger..... Assemble drive unit to mounting frame and install bit	0.50
------------------------------------------------------------------------	------

Prices and Specifications
Prices

VersaHANDLER TTC Attachments

North American Suggested List

Subject to Change Without Notice

All Prices in U.S. Dollars

2017 Price Book

Check BobcatNET Pricing Homepage for current Canadian exchange rate.

Page 9 of 25

Bobcat® and the Bobcat logo are trademarks of Bobcat Company.

Only these Attachments meet the ASME B56.6 Requirements for Telescopic Tool Carriers.

Other attachments are not approved for use with the VersaHANDLER TTC.

BUCKET

VersaHANDLER® TTC ATTACHMENT

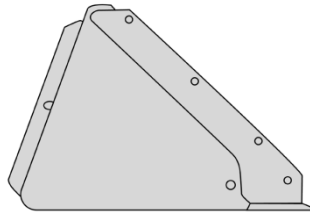

ATTACHMENT

PART NUMBER	DESCRIPTION	SAE HEAPED CAPACITY (YD)	OPER. WGT.	SLP IN US \$
-------------	-------------	--------------------------	------------	--------------

(V519)				
7125917	84" HD C&I BUCKET ♦.....	.88	758	\$1,676.00
6726328	88" HD C&I BUCKET ♦.....	.91	775	\$1,779.00
6727787	100" SNOW BUCKET ♦♦.....	2.0	878	\$1,879.00
(V723)				
7329888	93" GENERAL PURPOSE BUCKET.....	1.0	919	\$2,538.00
7338655	96" LIGHT MATERIAL BUCKET ♦♦♦.....	2.5	1554	\$3,299.00
7338662	96" LIGHT MATERIAL XL BUCKET ♦♦♦.....	3.2	1753	\$4,111.00

- ♦ Buckets have holes predrilled to accept bolt-on teeth.
- ♦♦ Bucket has holes predrilled to accept bolt-on cutting edges.
- ♦♦♦ Bucket has bolt-on cutting edge.

DEALER INSTALLED ACCESSORIES – ORDER FROM PARTS

PART NUMBER	DESCRIPTION
-------------	-------------

For current Dealer Installed Accessories pricing, reference BobQuote or Dealer Parts Department.

6737322	8 BOLT-ON TEETH KIT.....	PARTS	\$ _____
	<small>(Must purchase multiple of 8: 8x\$27.85=\$222.80) (Tooth Assembly includes Bolt-on Shank with Pin-on Tooth) (Hardware included)</small>		
7107319	STANDARD FORGED TOOTH POINT.....	PARTS	\$ _____
	<small>(Replacement Pin-on Tooth Point for S130-T320 Buckets) (Qty. 1)</small>		
7107317	HENSLEY FORGED TOOTH POINT.....	PARTS	\$ _____
	<small>(Replacement Pin-on Tooth Point for S130-T320 Buckets) (Qty. 1)</small>		
7107320	HENSLEY TIGER TOOTH POINT.....	PARTS	\$ _____
	<small>(It is recommended that the Hensley Twin Tiger Tooth Point p/n 7107321 be used at each end of the bucket when using the tiger tooth points) (Qty. 1)</small>		
7107321	HENSLEY TWIN TIGER TOOTH POINT.....	PARTS	\$ _____
	<small>(Qty. 1)</small>		

DESTINATION CHARGE

Refer to BobQuote or BobcatNET>>Other Resources>>Pricing Homepage for current Destination and Fuel Charges.

ATTACHMENT	ASSEMBLY REQUIRED	INSTALLATION TIME (HRS.)
------------	-------------------	--------------------------

Teeth	Bolt to bucket	0.5
-------------	----------------------	-----

Prices and Specifications **VersaHANDLER TTC Attachments** North American Suggested List Prices
 Subject to Change Without Notice All Prices in U.S. Dollars 2017 Price Book
 Check BobcatNET Pricing Homepage for current Canadian exchange rate. Page 10 of 25
 Bobcat® and the Bobcat logo are trademarks of Bobcat Company.

Only these Attachments meet the ASME B56.6 Requirements for Telescopic Tool Carriers.
 Other attachments are not approved for use with the VersaHANDLER TTC.

COMBINATION BUCKET

VersaHANDLER® TTC ATTACHMENT

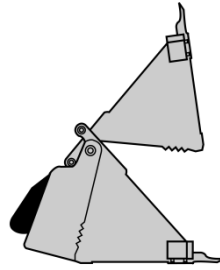

QUICK SPECS

Operating Weight	<u>84"</u> 1109 lbs.
Overall Width	85.4"
SAE Capacity Heaped	19.3 ft ³
Number of Teeth.....	9 bolt-on
Max Clamping Force	6835 lbs.

PART NUMBER	ATTACHMENT DESCRIPTION	SLP IN US \$
(V519) 7167314	84" COMBINATION BUCKET	\$4,750.00

DEALER INSTALLED ACCESSORIES – ORDER FROM PARTS

PART NUMBER	DESCRIPTION
-------------	-------------

For current Dealer Installed Accessories pricing, reference BobQuote or Dealer Parts Department.

6737322	8 BOLT-ON TEETH KIT	PARTS	\$ _____
	(Must purchase multiple of 8: 8x\$27.85=\$222.80) (Tooth Assembly includes Bolt-on Shank with Pin-on Tooth) (Hardware included)		
6807069	BOLT-ON CUTTING EDGE, 84"	PARTS	\$ _____
	(Hardware not included) (Estimated install time 1.5 hours)		

DESTINATION CHARGE

Refer to BobQuote or BobcatNET>>Other Resources>>Pricing Homepage for current Destination and Fuel Charges.

ATTACHMENT	ASSEMBLY REQUIRED	INSTALLATION TIME (HOURS)
------------	-------------------	---------------------------

Combination Bucket.....None.....

Prices and Specifications
Prices

VersaHANDLER TTC Attachments

North American Suggested List

Subject to Change Without Notice

All Prices in U.S. Dollars

2017 Price Book

Check BobcatNET Pricing Homepage for current Canadian exchange rate.

Page 11 of 25

Bobcat® and the Bobcat logo are trademarks of Bobcat Company.

Only these Attachments meet the ASME B56.6 Requirements for Telescopic Tool Carriers.
Other attachments are not approved for use with the VersaHANDLER TTC.

FLAIL CUTTER

VersaHANDLER® TTC ATTACHMENT

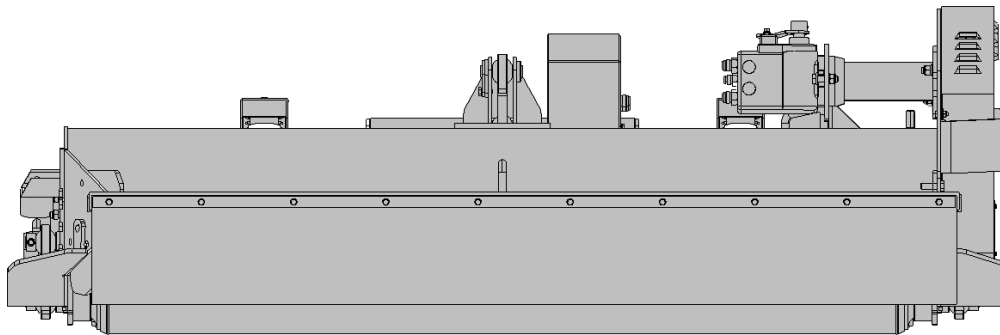

QUICK SPECS

Operating Weight.....	1,640 lbs.
Cutting Width.....	79"
Cutting Height.....	1.5" – 3"
Overall Width.....	91"
Flow	17 – 40 gpm
Hammers	21
Cutting Capacity	Brush material up to 3" in diameter
Blade Tip Speed.....	8200 ft./min. @ 2000 RPM 9000 ft./min. @ 2200 RPM

PART	ATTACHMENT	SLP IN US \$
NUMBER	DESCRIPTION	

(V519)		
7101894	FC200 FLAIL CUTTER.....	\$12,499.00

DESTINATION CHARGE/FUEL SURCHARGE

Refer to BobQuote or BobcatNET>>Other Resources>>Pricing Homepage for current Destination and Fuel Charges.

ATTACHMENT	INSTALLATION TIME (HOURS)
------------	---------------------------

Flail Cutter	None..... -
--------------------	-------------

Prices and Specifications
Prices

VersaHANDLER TTC Attachments

North American Suggested List

Subject to Change Without Notice

All Prices in U.S. Dollars

2017 Price Book

Check BobcatNET Pricing Homepage for current Canadian exchange rate.

Page 12 of 25

Bobcat® and the Bobcat logo are trademarks of Bobcat Company.

Only these Attachments meet the ASME B56.6 Requirements for Telescopic Tool Carriers.
Other attachments are not approved for use with the VersaHANDLER TTC.

GRAPPLE, AG & INDUSTRIAL

VersaHANDLER® TTC ATTACHMENT



Ag Grapple

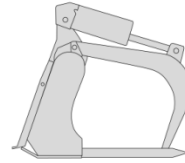

Industrial Fork Grapple

QUICK SPECS

	<u>90" Ag Bkt.</u>	<u>78" Fork</u>
Operating Weight	1113 lbs.	1218 lbs.
Overall Grapple Width	91.8"	78.8"
# of Teeth - Factory	N/A	8
# of Teeth - Possible	N/A	15

PART	ATTACHMENT	SLP IN US \$
NUMBER	DESCRIPTION	

(V519)		
7166624	78" INDUSTRIAL FORK GRAPPLE, WITH 8 TEETH.....	\$4,922.00
(V723)		
7328472	90" AG BUCKET GRAPPLE.....	\$6,268.00

DESTINATION CHARGE

Refer to BobQuote or BobcatNET>>Other Resources>>Pricing Homepage for current Destination and Fuel Charges.

ASSEMBLY REQUIRED	INSTALLATION
ATTACHMENT	TIME (HOURS)

Industrial Grapple.....None.....	0
----------------------------------	---

Prices and Specifications
Prices

VersaHANDLER TTC Attachments

North American Suggested List

Subject to Change Without Notice

All Prices in U.S. Dollars

2017 Price Book

Check BobcatNET Pricing Homepage for current Canadian exchange rate.

Page 13 of 25

Bobcat® and the Bobcat logo are trademarks of Bobcat Company.

Only these Attachments meet the ASME B56.6 Requirements for Telescopic Tool Carriers.

Other attachments are not approved for use with the VersaHANDLER TTC.

GRAPPLE, ROOT

VersaHANDLER® TTC ATTACHMENT

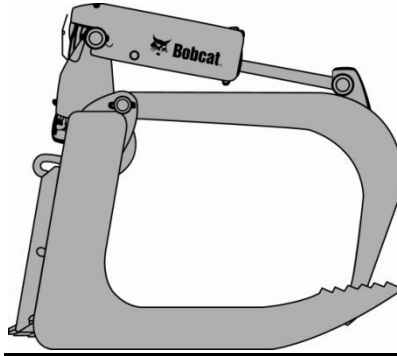

QUICK SPECS

	<u>82"</u>
Operating Weight	1130 lbs.
Height (closed)	34.2"
Height (open).....	51.8"
Length.....	42.8"
Width	82.5"
Teeth.....	11

PART NUMBER	DESCRIPTION	ATTACHMENT	SLP IN US \$
----------------	-------------	------------	--------------

	(V519)	7168338 82" ROOT GRAPPLE	\$3,818.00
--	--------	-------------------------------------	------------

DESTINATION CHARGE

Refer to BobQuote or BobcatNET>>Other Resources>>Pricing Homepage for current Destination and Fuel Charges.

ATTACHMENT	ASSEMBLY REQUIRED	INSTALLATION TIME (H)
------------	-------------------	--------------------------

Prices and Specifications
Prices

VersaHANDLER TTC Attachments

North American Suggested List

Subject to Change Without Notice

All Prices in U.S. Dollars

2017 Price Book

Check BobcatNET Pricing Homepage for current Canadian exchange rate.

Page 14 of 25

Bobcat® and the Bobcat logo are trademarks of Bobcat Company.

Only these Attachments meet the ASME B56.6 Requirements for Telescopic Tool Carriers.
Other attachments are not approved for use with the VersaHANDLER TTC.

PALLET FORK (fixed)

VersaHANDLER® TTC ATTACHMENT

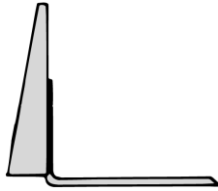

Pallet Fork Teeth and Frame

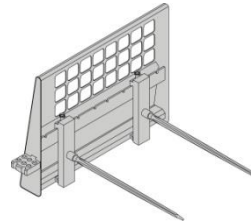

Bale Forks (2) and Frame

QUICK SPECS

Frame	V519		V723
.....			fixed
Weight.....	358 lbs.		fixed/ss
			717 lbs. 893 lbs.
Forks	42"	48"	Bale Forks
Ship Weight (set of 2)	215 lbs.	238 lbs.	single 42.7 lbs.
Fork Width	4"	4"	included included
			4" 4"

PART NUMBER	ATTACHMENT DESCRIPTION	SLP IN US \$
-------------	------------------------	--------------

(V519)		
7294332	PALLET FORK FRAME, HEAVY DUTY, LESS TEETH	\$639.00
	<i><u>Bale Forks</u></i>	
6815781	BALE FORKS, SET OF 2.....	\$672.00
	<i><u>Pallet Forks</u></i>	
6541521	42" PALLET FORK TEETH, SET OF 2.....	\$396.00
6541518	48" PALLET FORK TEETH, SET OF 2.....	\$447.00
(V723)		
7329891	PALLET FORK FRAME WITH 47" TEETH.....	\$1,624.00
7328474	PALLET FORK FRAME WITH 47" TEETH AND SIDESHIFT.....	\$3,502.00
	<i><u>Bale Fork</u></i>	
7329894	BALE FORK, SINGLE	\$330.00

DESTINATION CHARGE

Refer to BobQuote or BobcatNET>>Other Resources>>Pricing Homepage for current Destination and Fuel Charges.

ATTACHMENT	ASSEMBLY REQUIRED	INSTALLATION TIME (HOURS)
------------	-------------------	---------------------------

Pallet Fork Frame.....	Install forks on frame (V519 only)25
------------------------	------------------------------------------	-----

Prices and Specifications	VersaHANDLER TTC Attachments	North American Suggested List
Prices		
Subject to Change Without Notice	All Prices in U.S. Dollars	2017 Price Book
Check BobcatNET Pricing Homepage for current Canadian exchange rate.		Page 15 of 25

Bobcat® and the Bobcat logo are trademarks of Bobcat Company.
Only these Attachments meet the ASME B56.6 Requirements for Telescopic Tool Carriers.
Other attachments are not approved for use with the VersaHANDLER TTC.

PALLET FORK - FLOATING

VersaHANDLER® TTC ATTACHMENT

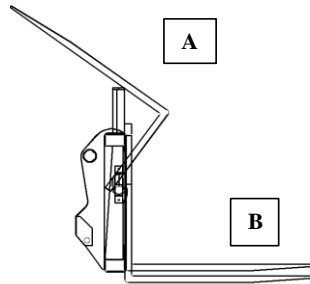

A – Lowback Forks will float and pivot up B – Highback Forks will float only

QUICK SPECS

Pallet Frames	<u>48" Pallet Fork Frame</u>	<u>44" Frame</u>	<u>56" Frame</u>
Operating Weight.....	492 lbs.	617 lbs.	683 lbs.
Frame Width	49.9"	44.1"	56.7"
Frame Height.....	51.7"		
Pallet Forks	<u>Lowback Forks</u>	<u>Highback Forks</u>	
Operating Weight (set of 2).....	272 lbs.	316 lbs.	
Fork Width	4"	4"	
Fork Back Height	26"	39"	
Fork Length.....	48"	48"	
Float up/down	3"	-	
Rotation.....	144°	-	

PART	ATTACHMENT	
NUMBER	DESCRIPTION	SLP IN US \$

(V519)		
7140717	48" PALLET FORK FRAME, LESS TEETH.....	\$1,802.00
6810302	48" LOWBACK PALLET FORK TEETH, SET OF 2.....	\$933.00
6810301	48" HIGHBACK PALLET FORK TEETH, SET OF 2.....	\$1,200.00

(V723)		
7329892	44" PALLET FORK FRAME, WITH 2 LOW BACK FORKS.....	\$1,675.00
7329893	56" PALLET FORK FRAME, WITH 2 LOW BACK FORKS.....	\$1,751.00

DESTINATION CHARGE

Refer to BobQuote or BobcatNET>>Other Resources>>Pricing Homepage for current Destination and Fuel Charges.

ASSEMBLY REQUIRED	INSTALLATION
ATTACHMENT	TIME (HRS.)

Pallet Fork Frame..... Install forks on frame (V519 only)25
-----------------------------------------------------------------	-----

Prices and Specifications Prices	VersaHANDLER TTC Attachments	North American Suggested List
Subject to Change Without Notice	All Prices in U.S. Dollars	2017 Price Book
Check BobcatNET Pricing Homepage for current Canadian exchange rate.		Page 16 of 25

Bobcat® and the Bobcat logo are trademarks of Bobcat Company.

Only these Attachments meet the ASME B56.6 Requirements for Telescopic Tool Carriers.
Other attachments are not approved for use with the VersaHANDLER TTC.

ROCK BUCKET

VersaHANDLER® TTC ATTACHMENT

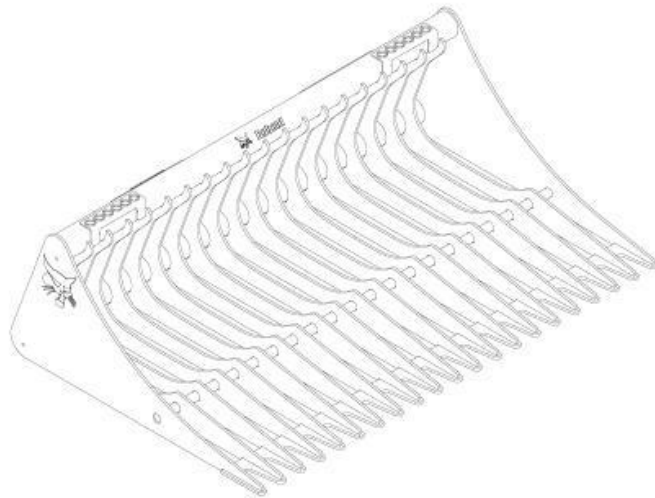

QUICK SPECS

Operating Weight.....	<u>82"</u> 700 lbs.
Overall Width.....	82.1"
Overall Height.....	20.8"
Overall Length (Bucket Lip or Bottom of Bucket)	43.57"
Tine Spacing.....	3 in.
Number of Tines.....	23

PART NUMBER	ATTACHMENT DESCRIPTION	SLP IN US \$
(V519) 7185947	82" ROCK BUCKET.....	\$1,774.00

DESTINATION CHARGE

Refer to BobQuote or BobcatNET>>Other Resources>>Pricing Homepage for current Destination and Fuel Charges.

Prices and Specifications
Prices

VersaHANDLER TTC Attachments

North American Suggested List

Subject to Change Without Notice

All Prices in U.S. Dollars

2017 Price Book

Check BobcatNET Pricing Homepage for current Canadian exchange rate.

Page 17 of 25

Bobcat® and the Bobcat logo are trademarks of Bobcat Company.

Only these Attachments meet the ASME B56.6 Requirements for Telescopic Tool Carriers.

Other attachments are not approved for use with the VersaHANDLER TTC.

SNOW BLADE

VersaHANDLER® TTC ATTACHMENT

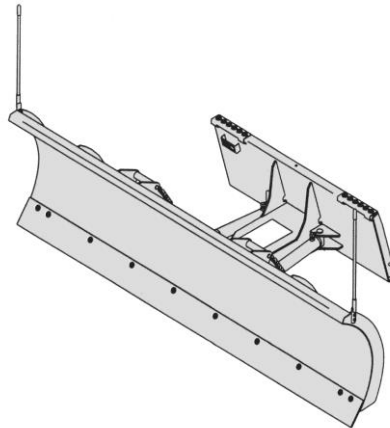

QUICK SPECS

	<u>108" HD</u>
Operating Weight	948 lbs.
Width	108"
Height	28.5"
Working Width (Fully Angled)	94"
Steel Cutting Edge5" x 6"
Cylinders.....	1
Trip Springs	6
Optional Rubber Cutting Edge	1" x 6"

PART NUMBER	ATTACHMENT DESCRIPTION	SLP IN US \$
-------------	------------------------	--------------

(V519)		
7207863	108" SNOW BLADE – HEAVY DUTY (WITH HYDRAULIC ANGLE).....	\$4,381.00

PART NUMBER	DEALER INSTALLED ACCESSORIES – ORDER FROM PARTS DESCRIPTION
-------------	-------------------------------------------------------------

For current Dealer Installed Accessories pricing, reference BobQuote or Dealer Parts Department.

7165988	END WING KIT <small>(Converts 86", 96" & 108" HD Snow Blades in to Snow Pushers)</small>	PARTS	\$ _____
7169615	RUBBER WEAR EDGE KIT, 108" HD.....	PARTS	\$ _____
7169618	POLY WEAR EDGE KIT, 108" HD	PARTS	\$ _____
7160646	REPLACEMENT CUTTING EDGE, 108" HD ♦	PARTS	\$ _____

- ♦ Additional hardware for replacement cutting edges is needed.
- Certain applications may cause premature wear of the Rubber Wear Edge.

Prices and Specifications
Prices

VersaHANDLER TTC Attachments

North American Suggested List

Subject to Change Without Notice

All Prices in U.S. Dollars

2017 Price Book

Check BobcatNET Pricing Homepage for current Canadian exchange rate.

Page 18 of 25

Bobcat® and the Bobcat logo are trademarks of Bobcat Company.

Only these Attachments meet the ASME B56.6 Requirements for Telescopic Tool Carriers.

Other attachments are not approved for use with the VersaHANDLER TTC.

SNOW BLADE

VersaHANDLER® TTC ATTACHMENT

DESTINATION CHARGE
Refer to BobQuote or BobcatNET>>Other Resources>>Pricing Homepage for current Destination and Fuel Charges.

ATTACHMENT	ASSEMBLY REQUIRED	INSTALLATION TIME (HOURS)
------------	-------------------	------------------------------

Snow Blade	Adjust shoes & install blade edge indicators25
End Wing Kit	Install wings25
Replacement Cutting Edge Kits	Bolt on edge	0.50

Prices and Specifications
Prices

VersaHANDLER TTC Attachments

North American Suggested List

Subject to Change Without Notice

All Prices in U.S. Dollars

2017 Price Book

Check BobcatNET Pricing Homepage for current Canadian exchange rate.

Page 19 of 25

Bobcat® and the Bobcat logo are trademarks of Bobcat Company.

Only these Attachments meet the ASME B56.6 Requirements for Telescopic Tool Carriers.

Other attachments are not approved for use with the VersaHANDLER TTC.

SNOWBLOWER

VersaHANDLER® TTC ATTACHMENT

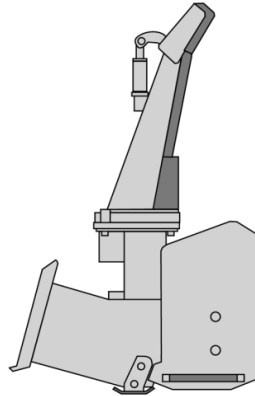

QUICK SPECS

	<u>SB200 x 78</u>	<u>SB240 x 72</u>	<u>SB240 x 84</u>
Chute Control	Hydraulic	Hydraulic	Hydraulic
	270°	270°	270°
Deflector Control....	Hydraulic	Hydraulic	Hydraulic
Throw Distance.....	Up to 40 ft.	Up to 40 ft.	Up to 40 ft.
Flow Required	16.5 - 31 gpm	21 - 31 gpm	25 - 31 gpm
Fan Diameter	20"	24"	24"
Auger Diameter	14"	18"	18"
Cutting Width	78"	72"	84"
Overall Width	80.5"	74.5"	86.5"
Intake Height	25"	34.5"	34.5"
Operating Weight ...	860 lbs.	1010 lbs.	1070 lbs.

HYDRAULIC MOTOR PACKAGES HYDRAULIC FLOW RANGE

Must order a Hydraulic Motor Package with the SB200 & SB240 Snowblower Models

6.2 Hydraulic Motor Package	16.5 – 21 gpm
8.0 Hydraulic Motor Package	21 – 26 gpm

Prices and Specifications
Prices

VersaHANDLER TTC Attachments

North American Suggested List

Subject to Change Without Notice

All Prices in U.S. Dollars

2017 Price Book

Check BobcatNET Pricing Homepage for current Canadian exchange rate.

Page 20 of 25

Bobcat® and the Bobcat logo are trademarks of Bobcat Company.

Only these Attachments meet the ASME B56.6 Requirements for Telescopic Tool Carriers.

Other attachments are not approved for use with the VersaHANDLER TTC.

SNOWBLOWER

VersaHANDLER® TTC ATTACHMENT

PART NUMBER	DESCRIPTION	SB200 SNOWBLOWER	SLP IN US \$
-------------	-------------	------------------	--------------

(V519)

M7004	SB200 x 78" Snowblower	\$5,047.00
M7004-R01-C02	6.2 Hydraulic Motor Package	\$1,108.00
M7004-R01-C03	8.0 Hydraulic Motor Package.....	\$1,171.00

PART NUMBER	DESCRIPTION	SB240 SNOWBLOWER	SLP IN US \$
-------------	-------------	------------------	--------------

(V519)

M7005	SB240 x 72" Snowblower	\$6,376.00
M7005-R01-C03	8.0 Hydraulic Motor Package	\$1,171.00

(V519)

M7006	SB240 x 84" Snowblower	\$6,407.00
M7006-R01-C03	8.0 Hydraulic Motor Package	\$1,171.00

Prices and Specifications
Prices

VersaHANDLER TTC Attachments

North American Suggested List

Subject to Change Without Notice

All Prices in U.S. Dollars

2017 Price Book

Check BobcatNET Pricing Homepage for current Canadian exchange rate.

Page 21 of 25

Bobcat® and the Bobcat logo are trademarks of Bobcat Company.

Only these Attachments meet the ASME B56.6 Requirements for Telescopic Tool Carriers.

Other attachments are not approved for use with the VersaHANDLER TTC.

SOIL CONDITIONER

VersaHANDLER® TTC ATTACHMENT

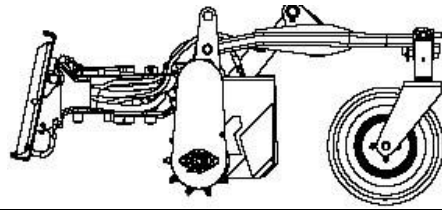

QUICK SPECS

	<u><i>84-in Hyd.</i></u>
Overall Length	67.9"
Overall Width	98.2"
Working Width – Fully Angled.....	76.0"
Degree of Angle – Left or Right.....	25 deg.
Number of Teeth.....	141
Operating Weight	1268 lbs.
Hydraulic Requirements	18-37 gpm
Tires	Foam-Filled
Float or Lock Position	Both
Depth Adjustment.....	Hydraulic

PART NUMBER	ATTACHMENT DESCRIPTION	SLP IN US \$
-------------	------------------------	--------------

(V519))	7135946 84" SOIL CONDITIONER, HYDRAULIC ANGLE	\$9,753.00
---------	----------------------------------------------------------	------------

DESTINATION CHARGE

Refer to BobQuote or BobcatNET>>Other Resources>>Pricing Homepage for current Destination and Fuel Charges.

ATTACHMENT	ASSEMBLY REQUIRED	INSTALLATION TIME (HOURS)
------------	-------------------	---------------------------

Soil ConditionerNone.....

Prices and Specifications
Subject to Change Without Notice
Check BobcatNET Pricing Homepage for current Canadian exchange rate.

VersaHandler Attachments
All Prices in U.S. Dollars

North American Suggested List Prices
2017 Price Book
Page 22 of 25

Only these Attachments meet the ASME B56.6 Requirements for Telescopic Tool Carriers.
Other attachments are not approved for use with the VersaHandler TTCs.

SWEEPER

VersaHANDLER® TTC ATTACHMENT



QUICK SPECS

	<u>84"</u>
Operating Weight	1029 lbs.
Sweep Width.....	84"
Overall Attachment Width.....	89.9"
Bucket Capacity.....	18.5 cu. ft.
Broom Diameter	24"
Bristle Sections (Included)	42
Bristle Material	Replaceable Polypropylene sections (steel sections available)
Cutting Edge (Repl. Steel).....	5/8" x 6"
Broom RPM @ 10 GPM	215 @ 15 GPM
Travel.....	Forward/Reverse

PART NUMBER	ATTACHMENT DESCRIPTION	SLP IN US \$
-------------	------------------------	--------------

(V519)		
7112646	84" SWEEPER.....	\$4,890.00

PART NUMBER	DEALER INSTALLED ACCESSORIES – ORDER FROM SALES DESCRIPTION	SLP IN US \$
-------------	-------------------------------------------------------------	--------------

7122418	GUTTER BRUSH	\$1,311.00
	(Includes hoses, couplers, steel bristles, mounting frame, hardware and control valve) (Estimated install time 2 hours) (Ship Weight 145 lbs.)	

PART NUMBER	DEALER INSTALLED ACCESSORIES – ORDER FROM PARTS DESCRIPTION	
-------------	-------------------------------------------------------------	--

For current Dealer Installed Accessories pricing, reference BobQuote or Dealer Parts Department.

7122537	WHEEL KIT, 84"	PARTS \$ _____
	(Add-on for the 84" Sweeper) (Limits surface damage due to scrapes and scratches) (Includes hardware, two wheels and gas shocks) (Estimated install time 2 hours)	
7104254	BOLT-ON CUTTING EDGE, 84"	PARTS \$ _____
	(Hardware not included) (Estimated install time 1.5 hours)	

Prices and Specifications Subject to Change Without Notice Check BobcatNET Pricing Homepage for current Canadian exchange rate.	VersaHandler Attachments All Prices in U.S. Dollars	North American Suggested List Prices 2017 Price Book Page 23 of 25
---------------------------------------------------------------------------------------------------------------------------------------	---------------------------------------------------------------	--------------------------------------------------------------------------

Only these Attachments meet the ASME B56.6 Requirements for Telescopic Tool Carriers.
Other attachments are not approved for use with the VersaHandler TTCs.

SWEEPER

VersaHANDLER® TTC ATTACHMENT

DESTINATION CHARGE
Refer to BobQuote or BobcatNET>>Other Resources>>Pricing Homepage for current Destination and Fuel Charges.

ATTACHMENT	ASSEMBLY REQUIRED	INSTALLATION TIME (HOURS)
-------------------	--------------------------	--------------------------------------

Sweeper	None.....	-
Gutter Brush	2.0

Prices and Specifications

VersaHandler Attachments

North American Suggested List Prices

Subject to Change Without Notice

All Prices in U.S. Dollars

2017 Price Book

Check BobcatNET Pricing Homepage for current Canadian exchange rate.

Page 24 of 25

Only these Attachments meet the ASME B56.6 Requirements for Telescopic Tool Carriers.
Other attachments are not approved for use with the VersaHandler TTCs.

TRUSS BOOM

VersaHANDLER® TTC ATTACHMENT



QUICK SPECS

Boom Weight..... 558 lbs.
 Boom Height 19.3"
 Boom Length 146"

PART NUMBER	ATTACHMENT DESCRIPTION	SLP IN US \$
-------------	------------------------	--------------

(V519) 7140714	12' TRUSS BOOM..... (Truss Broom is outfitted with Bob-Tach® mounting system tabs to prevent use on any carrier other than V417 or V519)	\$1,823.00
-------------------	---------------------------------------------------------------------------------------------------------------------------------------------	------------

DESTINATION CHARGE

Refer to BobQuote or BobcatNET>>Other Resources>>Pricing Homepage for current Destination and Fuel Charges.

ATTACHMENT	ASSEMBLY REQUIRED	INSTALLATION TIME (HRS.)
------------	-------------------	--------------------------

Truss Boom	None.....	-
------------------	-----------	---

Prices and Specifications
 Subject to Change Without Notice
 Check BobcatNET Pricing Homepage for current Canadian exchange rate.

VersaHandler Attachments
 All Prices in U.S. Dollars

North American Suggested List Prices
 2017 Price Book
 Page 25 of 25

Only these Attachments meet the ASME B56.6 Requirements for Telescopic Tool Carriers.
 Other attachments are not approved for use with the VersaHandler TTCs.